

Module A 6Hours

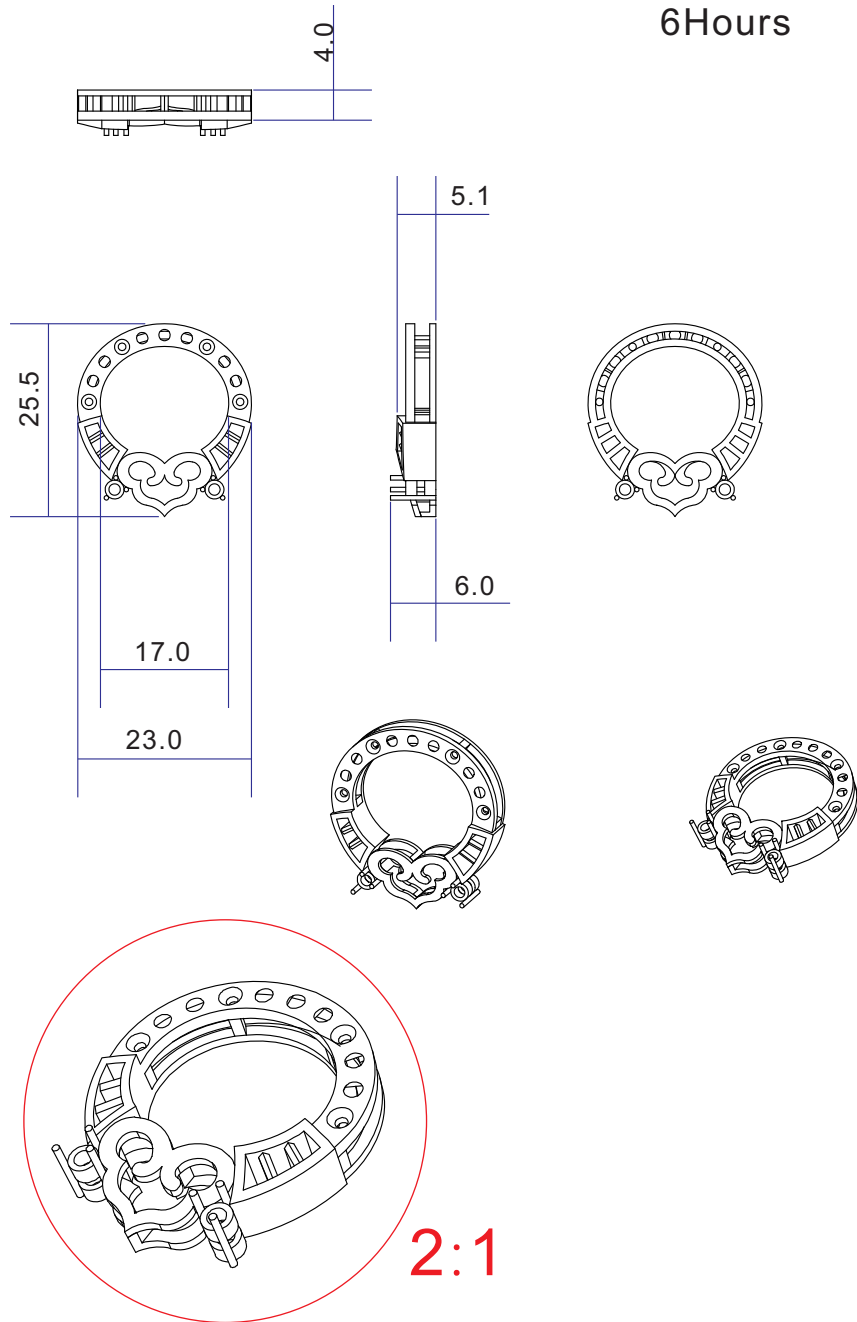

Module B 6Hours

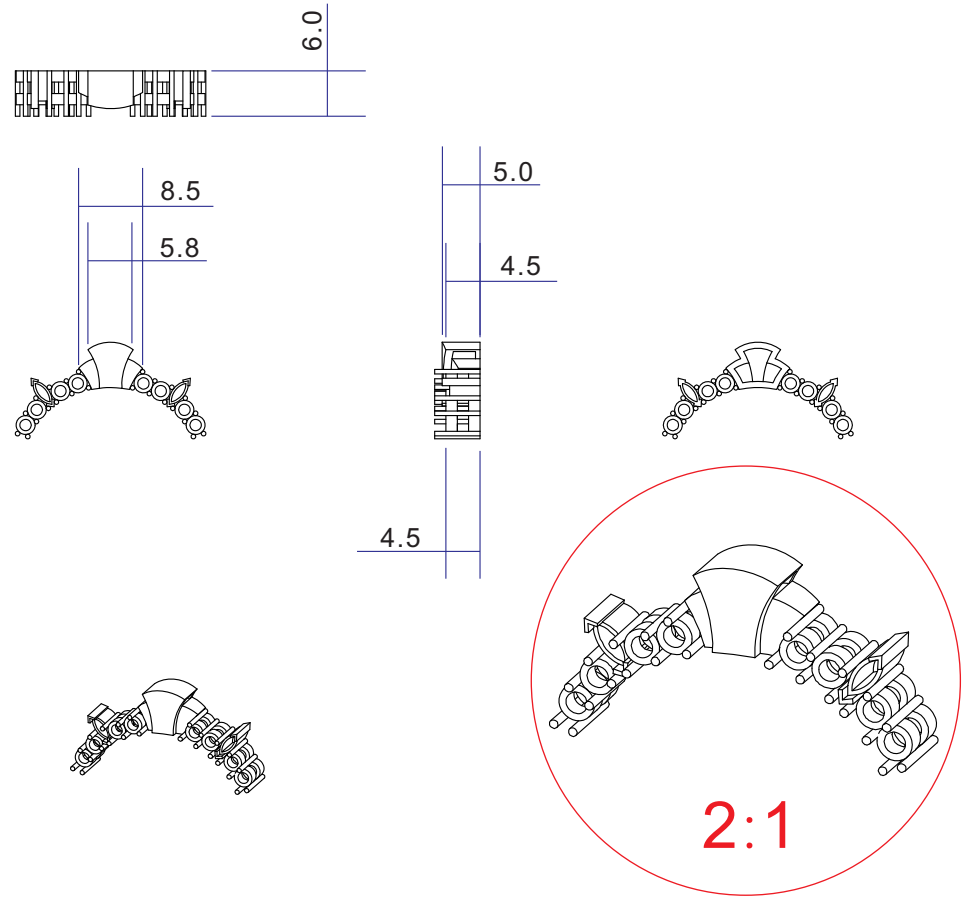

Test Project for the 42nd WorldSkills
Competition in Leipzig, Germany 2013.
Copyright © 2011 Worldskills International.
All Rights Reserved.



Skill: 27-Jewellery			OR	
Scale: 1:1	Date: 2011	Paper: A4	Drawing No: WSC2013_TP27_TW_01_EN	
Drawn / Design by: Mei-Jen Wang			Rev: 1	Page: 1/3
Description: 22Hr Test project				

Module C 6Hours

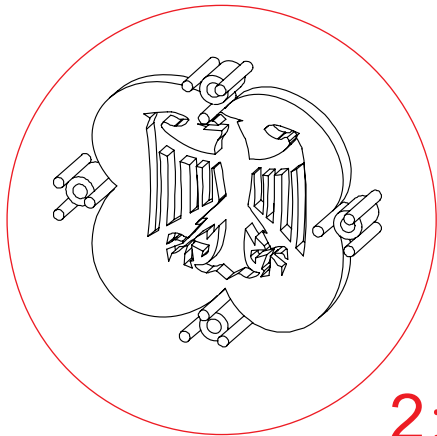
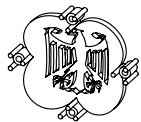
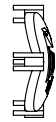
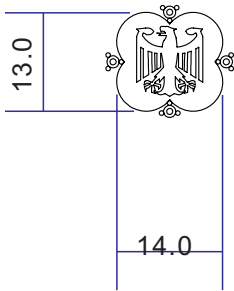
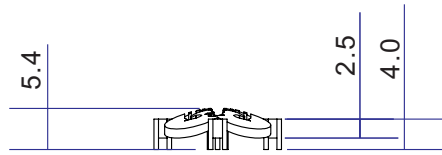

2:1

Module D 4Hours

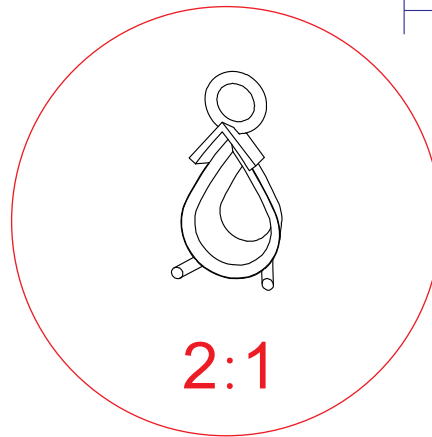
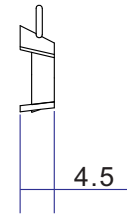
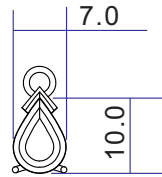
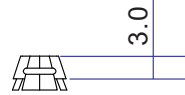

2:1

Test Project for the 42nd WorldSkills
Competition in Leipzig, Germany 2013.
Copyright © 2011 Worldskills International.
All Rights Reserved.



Skill: 27-Jewellery

Scale: 1:1 Date: 2011 Paper: A4

Drawn / Design by: Mei-Jen Wang

Description: 22Hr Test project

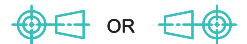

Drawing No: WSC2013_TP27_TW_01_EN

Rev: 1

Page: 2/3

1 2 3 4 5 6 7 8 9 10

A
B
C
D
E
F

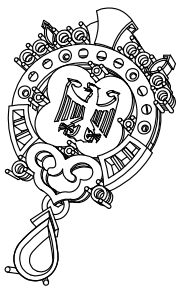
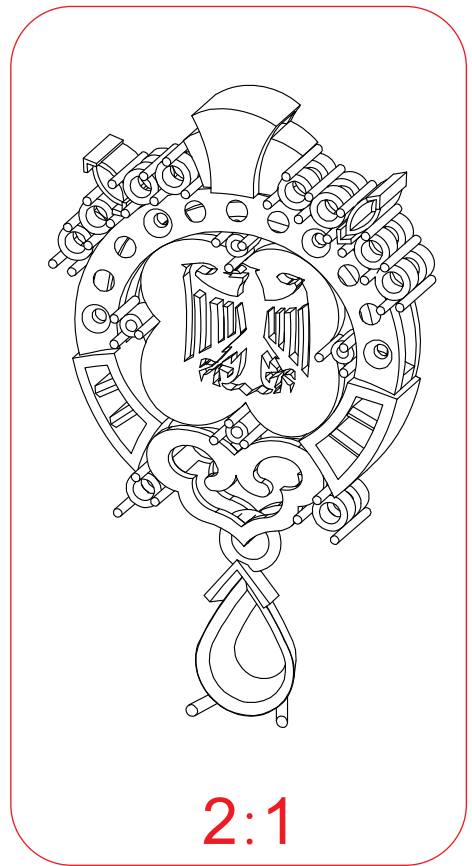
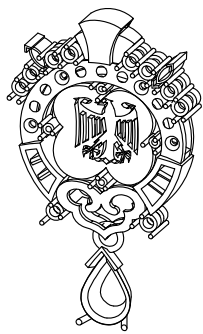
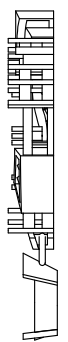
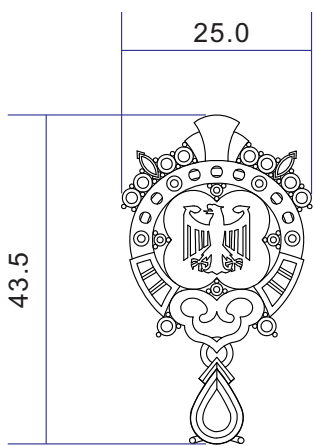
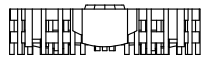

Module A+B+C+D



1 2 3 4 5 6 7 8 9 10

Test Project for the 42nd WorldSkills Competition in Leipzig, Germany 2013. Copyright © 2011 Worldskills International. All Rights Reserved.



Skill: 27-Jewellery			 OR 	
Scale: 1:1	Date: 2011	Paper: A4		
Drawn / Design by: Mei-Jen Wang			Drawing No: WSC2013_TP27_TW_01_EN	
Description: 22Hr Test project			Rev: 1	Page: 3/3